

Varenummer: 2307081254
 Beskrivelse: E+G Mini mekanisk tæller
 DD50-FN-05.0-S-AR Orange

Mål

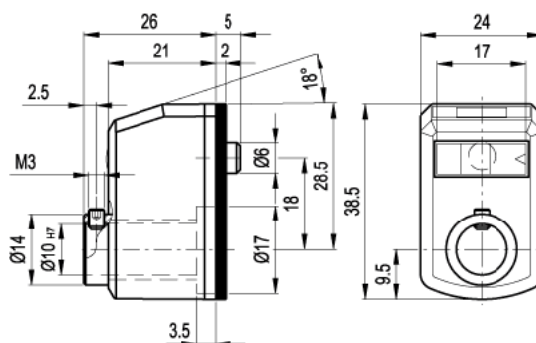

Table of possible combinations								
Reading position	Pitch	Reading after one revolution				Speed (rpm)*	Direction of rotation	Colour
		0	1	0	1			
AN axial upper	1.0	01.0	0.10	010	1500	D clockwise	AR orange RAL 2004	
AR axial lower	2.0	02.0	0.20	020	1250			
FN front upper	4.0	04.0	0.40	040	625	S anti-clockwise	GR grey RAL 7035	
FR front lower	5.0	05.0	0.50	050	500			
	10	10.0	1.00	100	250			

01.0	Standard reading
0.10	Reading available on request (see 17.4.2012)

DD50 - FR - 010 - S - GR

* The maximum rotation speed (rpm) of the spindle reported in the table corresponds to a maximum rotation speed of 25,000 units per minute of the test roll on the right side of the counter. Rotational speed tests have been performed in our laboratory under standard operating conditions.

Betegnelse = Se mål på tegning